



Slit Lamp Microscope
700GL
700GL NSW / LPH

Serving Your Vision



Slit Lamp Microscope 700GL

Crystal clear, high-definition observation utilising
the best optical design



TAKAGI has been serving the vision of the global eye-care industry since 1955. TAKAGI brand products are developed, designed and manufactured in Nagano, a region famed for its thriving precision manufacturing industry. Protecting eye health means protecting opportunities to see the beautiful things in the world. It is based on this belief that we take great joy and pride in making our instruments beautiful as well as functional. Our world-class technological capabilities, assured quality and outstanding service, make us trusted by ophthalmic professionals in more than 80 countries worldwide.

TAKAGI's slit lamps feature globally recognised technologies that are essential for high-quality eye care, including outstanding light source characteristics and reliable optics.

The unique design combines both style and usability, offering ease of operation and infection control.

The 700GL Slit Lamp is a premium optical system that optimises balance with the LED light source to realise crystal clear observation from the anterior eye segment to the fundus . It provides a sharp and clear slit illumination with minimal light and colour irregularities. Combining the very best in optical design and ergonomics has enabled the realisation of a slit lamp that is both easy to use and has a graceful appearance, with a built-in cable (patented technology). Special specifications catering to a broad variety of needs are also available, including those installed with NSW (Narrow angle Stereo Wide viewer) and LPH (Large Patient Headrest).

Design

Innovative design with a built-in cable

Adopting a ground-breaking design that keeps all cables, including power cables, out of sight and unexposed makes it possible to eliminate damage to cables caused by external factors, and so greatly reduces potential causes of failure. Even when connected with an imaging system all cables are unexposed, so there is no danger of objects or hands coming into contact with cables. Not only do these features improve safety, but they are also designed to be easy to clean and disinfect.

Functional beauty unique to TAKAGI

The clean and compact appearance of the 700GL gives an overall sense of cleanliness to the examination room, also raising expectations of functionality.

The ST-50 Smart Table, which has no exposed mechanical parts, and the CR-750S Motorised Patient Chair, which can be raised and lowered using buttons on the ST-50, can be used together for both greater convenience and safer examination.

TAKAGI slit lamps are equipped with a breath shield (S06-71 290mm (H) X 220mm (W)) as a standard feature to prevent droplet infection and ensure peace of mind during examinations.



* Examples of 700GL, ST-50, and CR-750S configurations.

Usability

Pursuit of comfort based on ergonomics

The size, feel, and positioning of control devices all have a significant impact on ease of use. The design of the 700GL has been optimised based on ergonomic principles to make operation simple and comfortable. The trigger button is located on the top of the joystick for one-handed control, enabling the user to take pictures while operating the joystick.

In addition to the rotating slit illumination the 700GL is equipped with tilting and left-right scanning, enabling a wide range of applications including retina examination. Using the optional 13° inclined adapter or tiltable binocular tubes helps to enhance neck and shoulder comfort and realise a comfortable sitting posture when using the slit lamp.

High-eyepoint eyepieces

700GL is equipped with high-eyepoint eyepieces. The distance from the observer's eye to the eyepiece is sufficient to allow observation even when wearing spectacles.

Imaging and informed consent

A background illumination device that brightens the background is included as standard, making it easy to capture observation images. The same LED as the main light source is also used for background illumination, which keeps the colour balance even and is also highly effective in visualising observation findings. The background light-intensity knob is next to the joystick for easy operation and allows the user to take pictures without losing concentration.

A diffuser is also included as standard to provide broad and uniform illumination of the anterior eye segment. Being able to use both background illumination and diffusers as and when needed not only enables a wide range of observation images to be captured, but it also helps with record keeping and informed consent.

The illumination field diameter is 14mm to maximise the capabilities of slit lamps with a wide field of view, which covers not only the average corneal diameter, but is also suited to soft contact lens (SCL) users. With minimal user operations it is possible to illuminate a large area.

* Integrated background illumination and built-in cables are patented technologies.

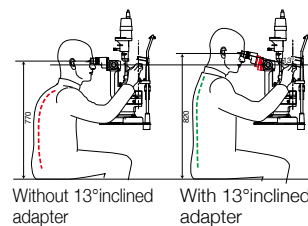

LED

Uniform LED light source provides bright and sharp illumination.

The 700GL is a slit lamp designed specifically for LED light sources.

LED with a colour temperature of 3500K provides white light and a natural observation image similar to that of halogen. The wavelength peak at 450 nm provides a sharp slit illumination.

A single element, high-luminance LED is used to realise a stable and uniform slit illumination by controlling the colour variations inherent in LEDs.

The bright and sharp light makes it possible to clearly see the details of hard-to-discern microstructures in the eye.

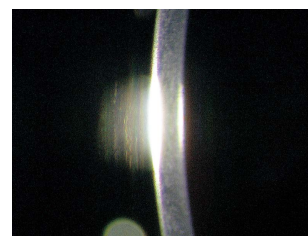

Bright and sharp LED light source

Optics

Clear observation of both the anterior and posterior segments of the eye

The 700GL has an inter-optical path distance of 22 mm, which provides a balanced three dimensional view of both the anterior and posterior segments of the eye. Binocular tubes tilt inwards at a 6° angle, helping to realise easy fusion and stress-free observation.

The volume of information in observation has a significant impact on the ease and accuracy of diagnosis and the size of the field of view is closely related to the volume of information. The 700GL, ensures a wide field of view (700GL standard specification 5 magnifications: 35.9 / 23.3 / 14 / 8.8 / 5.5 mm), and in so doing maximises the volume of information acquired. The wide field of view also has the effect of reducing the burden on the observing eye. In combination with a high-eyepoint, the wide field of view enables observation with a more natural eye line, thereby enhancing usability.

The 700GL NSW features a function that switches the stereo angle to 4.1°, enabling a wider 3D field of view than the 700GL and a more detailed view of the posterior eye segment. That is why, by turning the NSW function on, a sharp observation image from the corneal endothelium to the fundus tissue is realised. For further details see the section on the 700GL NSW.



Wide range of filters included as standard

When making observations in the original LED colour tone without using filters, light is easily diffused, making the cornea, aqueous humour, lens, and vitreous humour appear bright and sharp. In addition, while LEDs have other advantages such as high luminance and long life, they also have the potential to cause blue light-induced eye hazard when shone on the retina for extended periods. The 700GL comes with filters included as standard to protect patients' eyes from harmful light while leveraging the merits of LEDs, as well as filters to facilitate various types of observation.

The 700GL is equipped with a blue correction filter that produces a colour tone similar to that of a halogen lamp, while preventing blue light-induced damage. Also, by using the blue cut filter to block blue wave lengths, it is possible to provide a light that is even safer for the retina.

When observing red tissue such as blood vessels, a green (red-free) filter can be used to convert the red colours to black, enhancing contrast, which in turn allows clear contours to be observed.

For fluorescein staining observations, which are used in such situations as viewing corneal and conjunctival abnormalities, and the status of wounds or tears, a blue filter can be used for effective observation of fluorescence.

If a blue filter is used together with an optional S06-44 yellow filter for fluorescence observation, a fluorescein-stained image with even higher contrast (green) that cuts out blue colour can be obtained. This is also useful for contact lens fitting.

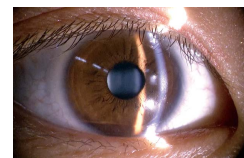
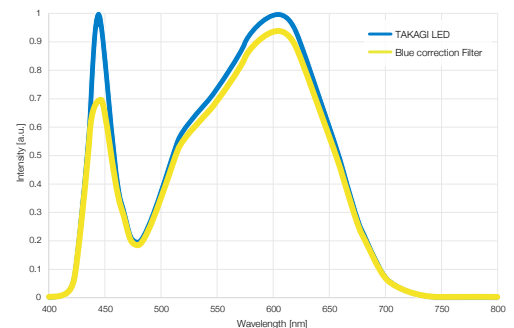

Filter not in use

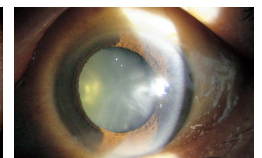

Blue correction filter in use

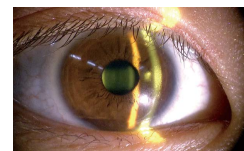

Blue cut filter in use

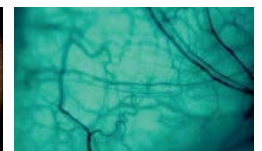

Observation image of blood vessels using green filter

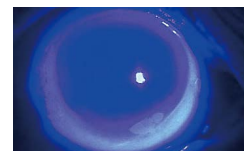

Fluorescence observation image using blue filter

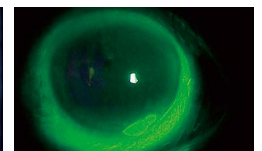

Blue filter used together with optional S06-44 yellow filter

Optimisation for digital imaging and image filing

The 700GL is equipped with cutting-edge illumination systems, including background illumination and diffusers, which are indispensable for image filing and imaging, all of which enable a wide range of illumination methods. Using a TAKAGI camera adapter it is possible to attach a C-mount camera or a Canon SLR camera to take pictures. (See the reverse for information about accessories.)

The background illumination built into the illumination unit is designed to always face the focal point, and can rotate from left to right by 90° on each side, just like the horizontal rotation movement range of the illumination unit. This range of movement enables illumination from multiple angles over a wide area.

For standard photography use the long mirror that is installed at time of delivery. A short mirror is also included as standard and is ideally suited to retinal photography.

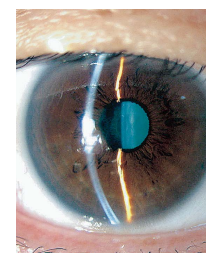

Imaging with TD-2 using background illumination



700GL with S10-17 in place

700GL NSW

Features of the 700GL NSW

Fundus examinations are important not only for observation of eye diseases and conditions such as abnormalities of the optic nerve and retinal blood vessels, retinal detachment, and uveitis, but also for assessing the possibility or progression of conditions such as hypertension, arteriosclerosis, and diabetes based on the collapse of blood vessel patterns.

Since a fundus camera is monocular, when used for fundus observation, the image is in 2D. As the 700GL NSW is binocular, the observation image as seen through the microscope is 3D, which has the advantage of enabling the examiner's naked eye to observe three-dimensional information that is more natural and detailed in real time.

In addition, when the slit lamp is used for fundus observation, this can be performed following the slit lamp examination in the same position, without the patient and doctor having to move, and so helping to shorten examination time. The NSW function narrows the observation optical path using a prism, enabling binocular observation of fundus even in patients with small pupils. The 700GL NSW can also record fundus observation images by installing an imaging system for slit lamp use.

In developing the 700GL NSW, we focused on the distance between the examiner and the patient, known as the Reaching Distance (RD), which is a factor considered to impact the stress level of the examiner, and devised a method to keep the RD the same as that of the 700GL, even when the NSW function is added to the 700GL (please see below). Normally, when you attach a device with an NSW function to a slit lamp, this has the effect of increasing the stress levels of the examiner due to the fact that the eyepieces are separated from the patient's eye by just the thickness of the device itself. As the RD of the 700GL NSW is the same as standard slit lamps, it is possible to maintain a normal examination environment and conduct comfortable fundus observations.

NSW construction

When observing the fundus with a slit lamp, binocular vision is obtained only in the area where the left and right visual fields overlap, and the larger the stereo angle, the narrower the binocular vision becomes. The 700GL NSW is fitted with a prism that changes the stereo angle, and the NSW function can be switched on by pushing the knob located underneath the lens unit. The NSW function increases the overlapping area of the left and right fields of view of the lens and expands the binocular field of view, enabling observation of the fundus over a wide area. When the knob is pulled out to turn off the NSW function, the slit lamp can then be used in the standard way.



Differences between 700GL and 700GL NSW

With a stereo angle set at 10°, the 700GL is a slit lamp that makes it comparatively easier to examine the fundus. On the 700GL NSW, when the NSW function is turned on the stereo angle becomes 4.1°, providing a 3D field of view approximately 133% wider than the 700GL, enabling detailed observation of the fundus. This slit lamp is ideally suited for use as a device for fundus examination in special outpatient clinics where fundus observations are frequently performed, or where a fundus camera is not available.

700GL NSW is a factory option specification. Please note that the standard 700GL cannot be modified/converted to 700GL NSW after purchase.

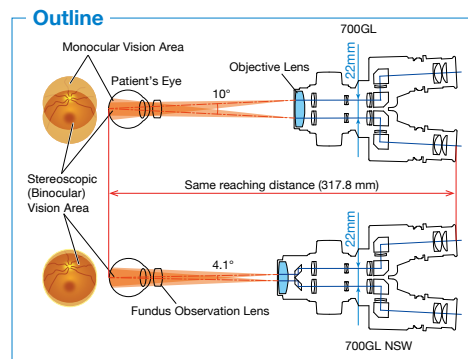

700GL LPH

The 700GL LPH features an LPH (Large Patient Headrest), where the headrest unit has been enlarged to create a larger space around the patient's chest area. Other specifications are the same as the 700GL.

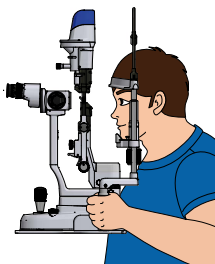

Features of the LPH

The 700GL LPH uses a larger headrest than the 700GL, creating a larger space around the patient's chest area. As the chest is not pressured by shaft of the headrest patients can be examined in comfort. As the headrest is larger, this also makes the product dimensions larger than standard specifications (see the dimensional drawing on the right).

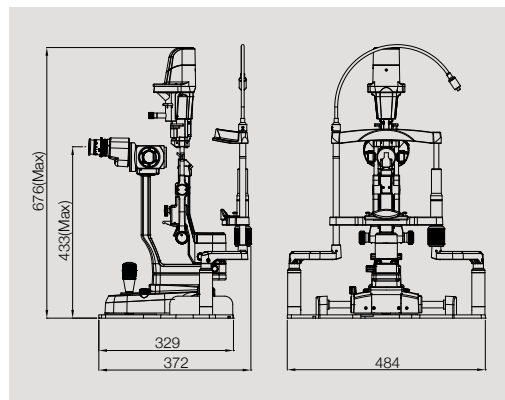

Specifications

Model name		700GL Slit Lamp Microscope	
		Standard	NSW
Microscope	Type	Galilean binocular stereo microscope	
	Magnification changer	5 position rotating drum	
	Eyeiece	16x widefield, high-eyepoint	12.5x widefield, high-eyepoint
	Total magnifications	6.3x, 10x, 16x, 25x, 40x	6x, 9x, 15x, 24x, 37x
	Field of view (diameter)	35.9, 23.3, 14, 8.8, 5.5 mm	37.8, 25.2, 15.1, 9.5, 6.0 mm
	Stereo angle	10°	4.1°(prism in) 12°(prism out)
	Interpupillary distance	52-82 mm	
	Eyeiece diopter range	± 7 D	± 5 D
	Working distance	119 mm (from objective lens to patient's eye)	98.3 mm (from objective lens to patient's eye)
	Focal length	125 mm (Objective lens)	105 mm (Objective lens)
Illumination Unit	Slit image width	Continuously variable 0-14 mm (almost circular at 14 mm)	
	Slit image length	Continuously variable 1-14 mm	
	Slit image rotation	Continuously variable 0-180°with 3 click stops at 45°, 90°, 135°	
	Slit decentration (horizontal)	Possible (fixable at 0°)	
	Slit inclination (vertical)	0°, 5°, 10°, 15°, 20°	
	Illumination field diameter	14, 10, 5, 3, 2, 1, 0.2 mm	
	scanning (decentration) angle	7° to the left, 7° to the right	
Base Unit	Filters	Blue / Green (red-free) / Blue correction / Blue cut	
	Light source	LED (3500K)	
Headrest Unit	Base unit operation	Single-handed joystick operation for forward-backward, left-right, up-down movement.	
	Movement range	105 mm (forward-backward, left-right), 30 mm (up-down)	
	Fine movement range	15 mm (forward-backward, left-right)	
Power Unit	Vertical movement range	95 mm	
	Fixation light	LED (red)	
Weight (excl. power adapter & options)	Power supply	AC 100-240 V (±10%), 0.4-0.2 A	
	Power input	DC 5 V 2 A	

Dimensions

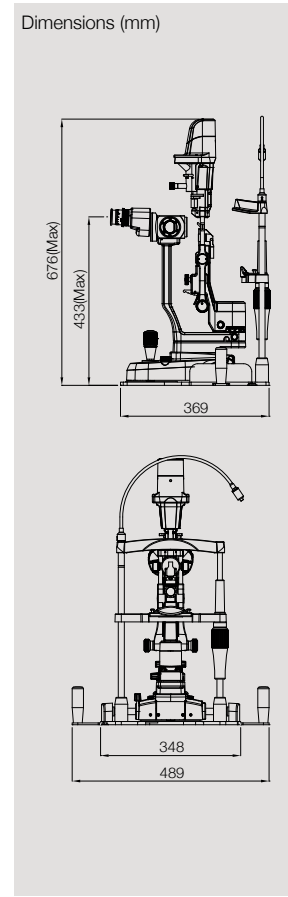

AT-1 Applanation tonometer



TD-2 Digital camera adaptor



TD12 Digital camera



Breath shield (H 290 mm x W 220 mm) as standard

System Chart

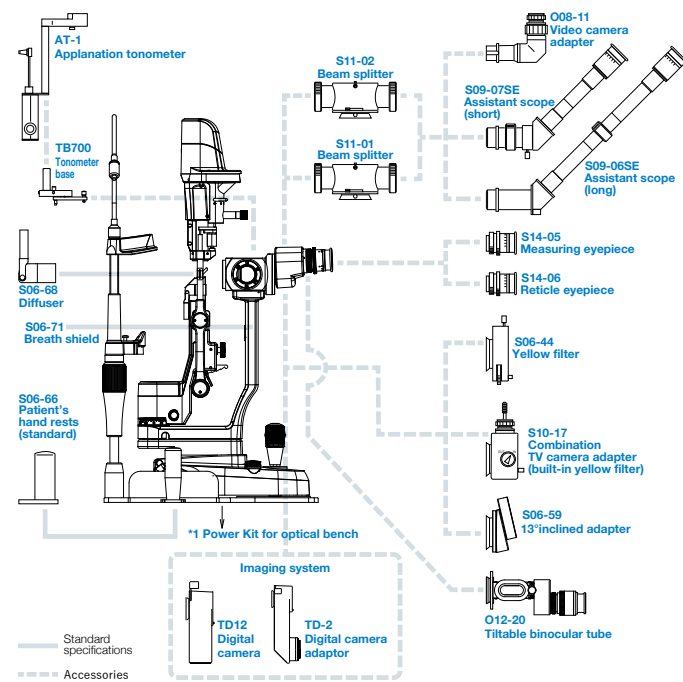

*1 Please contact our Sales Department for details about the power kit.

Accessories

Model number	Detailed information
AT-1	Applanation tonometer R-type (requires a tonometer base for installation)
O08-11	Adapter to connect TV or video camera F = 50 mm
O12-20	Binocular tube to change the angle of the eyepiece tube for enhanced neck/shoulder comfort.
S06-44	Yellow filter to enhance contrast for fluorescence observation
S06-59	13° inclined adapter to enhance neck/shoulder comfort
S06-66	Patient handrests so patient can grasp and comfortably maintain their posture during examinations (included as standard, available to purchase separately)
S06-68	Diffuses illumination, which is effective for observing the entire eye and peripheral areas of the eye at low magnification (included as standard, available to purchase separately)
S06-71	Breath shield (included as standard, available to purchase separately)
S09-06SE	Long monocular microscope for assistant
S09-07SE	Short monocular microscope for assistant
S10-17	Adapter fitted with beam splitter, camera adapter and yellow filter function
S11-01	Beam splitter to attach a camera or assistant microscope (spectroscopic ratio 40:60)
S11-02	Beam splitter to attach a camera or assistant microscope (spectroscopic ratio 30:70)
S14-05	Eyepiece with scale for measuring
S14-06	Eyepiece with reticle (crosshair)
TB700	Tonometer base for AT-1
TD-2	Adapter for attaching digital Canon SLR camera
TD12	Digital camera to be attached to slit lamp (including image filling software)

To ensure safe and correct handling please read the user manual before using.

- Description and appearance as detailed in this brochure may be subject to change as improvements are made to products.
- Colours as they appear in brochure photographs may be slightly different to actual products due to lighting conditions when photographs were taken, or print colours.



For The Americas, Asia-Pacific & Middle East
Takagi Seiko Co., Ltd
 330-2 Iwafune, Nakano-shi, Nagano-ken, 383-8585, Japan
 TEL : +81(0)269-22-6094 URL : <https://www.takagi-j.com>



For Europe & Africa
Takagi Ophthalmic Instruments Europe Ltd
 Citylabs 1.0, Nelson Street, Manchester, M13 9NQ, UK
 TEL : +44 (0)161 273 6330 URL : <https://www.takagi-europe.com>



Your local distributor